

3E CONCRETE REUSE
REUSE
RECYCLE

SYSTEM3E[®]

EXECUTION GUIDELINES

FOR CONSTRUCTION TEAMS

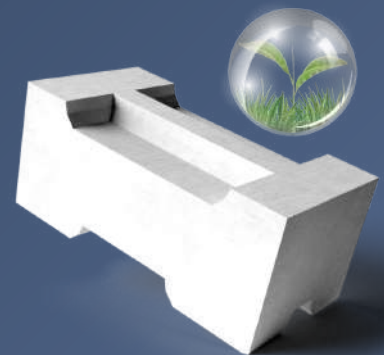

SYSTEM3E.COM

Foundation of the first layer – step by step

1 Establish the axes of the walls on the foundation and perform necessary leveling if the level difference at specific points exceeds **30 mm (e.g., between corners)**.

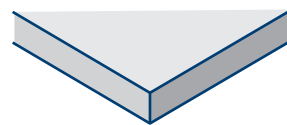

2 Apply **horizontal waterproofing** to protect the walls from capillary rising moisture.

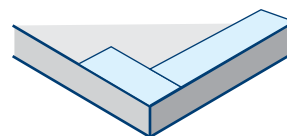

3 Apply a mortar layer for the foundation of the first layer. We recommend mortars with **strength classes ranging from M5 to M10**. Ensure the consistency is chosen such that SYSTEM 3E elements do not settle under their own weight or shift during curing.



4 Start laying the first layer of SYSTEM 3E elements from the corners on a **10 to 30 mm** mortar layer, ensuring proper vertical and horizontal alignment and securing against undesired displacement.

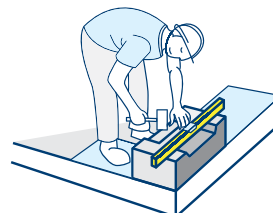

5 Use a mason's line or a level to **control the level and height between elements at corners** and other components forming the first layer.

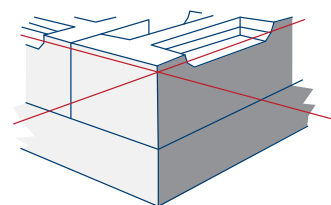

6 Place subsequent blocks between corners and ensure the upper surface of the elements is **at the same height**.

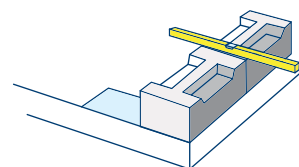

Wall Installation in SYSTEM 3E Technology

1 Ensure **proper cleaning of the upper surface** of elements before laying the next layer of SYSTEM 3E elements in the construction.

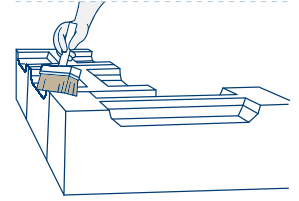

2 Lay successive layers **without mortar** using a click-click principle, preferably starting at the corners.

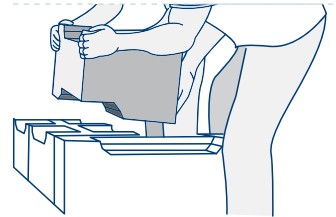

3 Fit elements using a rubber mallet, **avoiding heavy and hard tools** that may damage SYSTEM 3E blocks.

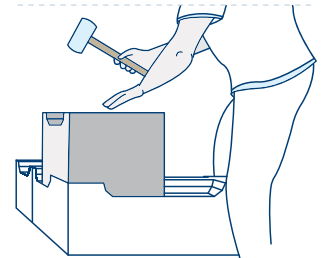

4 Lay successive elements of each layer **from the corners and continue around the building perimeter**, ensuring proper fitting along the wall direction.

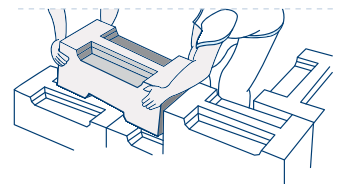

5 While laying elements, ensure the **same height of the upper surfaces** of consecutively placed elements.

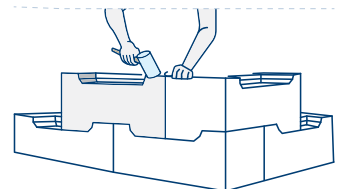

6 Start installing SYSTEM 3E walls **from the corners according to the technical design** provided as execution design documentation.

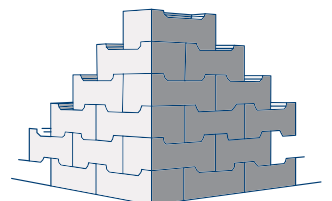

Consequences of Incorrect Element Installation in Construction

During the assembly of systemic elements, pay attention to proper fitting of blocks. A well-executed construction is free from damaged elements, cracks, and gaps. Incorrect usage on the construction site leads to the formation of gaps, cracks, and damage in straight structures.

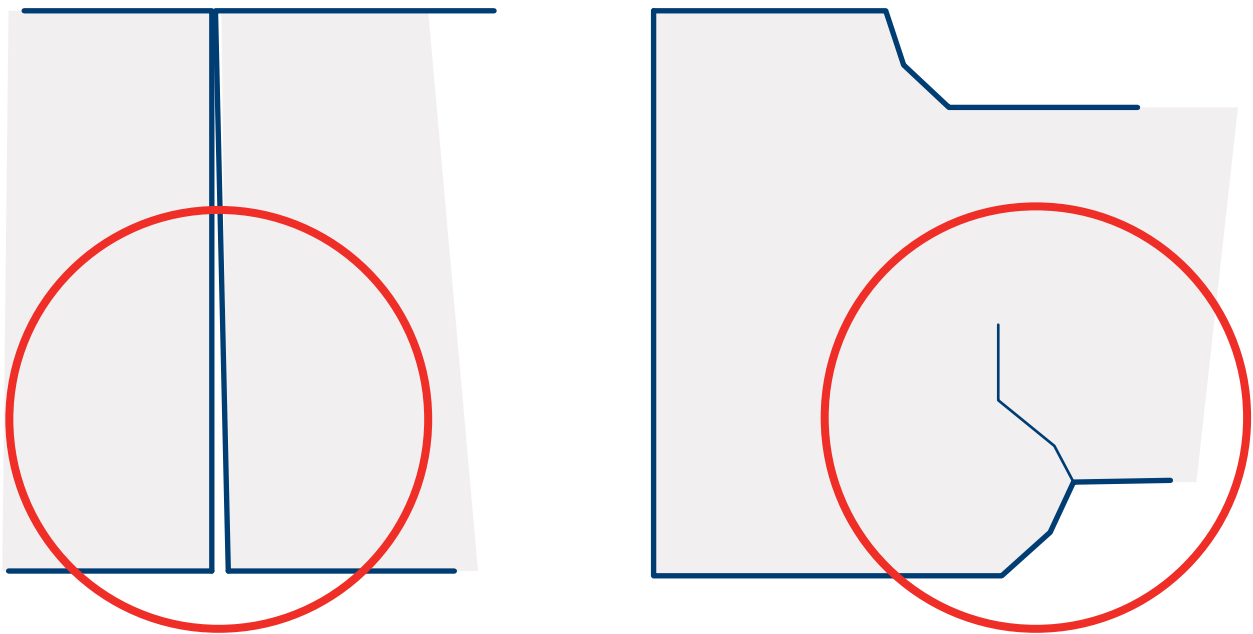

Correct installation of elements in construction

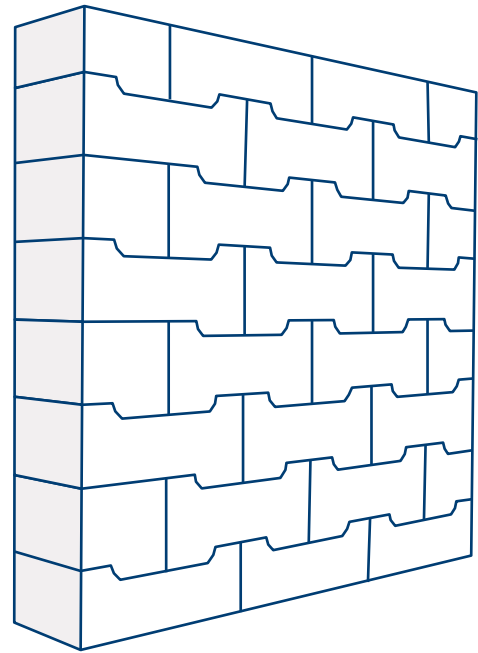

SYSTEM 3E elements exhibit high dimensional stability, allowing construction without the need for hammering or using other hard tools. Elements in the construction form a joint through the use of guiding and clamping surfaces on the geometry of the upper and lower connecting element.

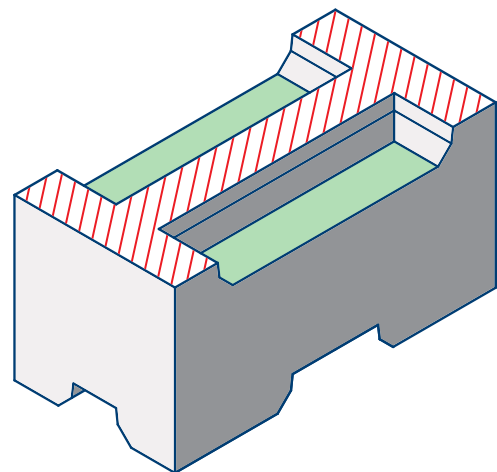

For the most ergonomic pressure point during assembly, based on our experience, focus on the green-marked side surfaces. Avoid damaging the geometry of the upper and lower locks of SYSTEM 3E elements.

Based on the experience of our construction workers, the most ergonomic place for conducting mechanical pressure during assembly is the side surfaces marked in green. It is important to avoid damaging the geometry of the upper and lower locks of SYSTEM 3E components.



-  Pressure points during wall assembly.
-  Areas to be avoided during compression.

Creating Grooves and Recesses for Installations

The fundamental principle is that grooves and recesses should not compromise the stability of the wall made in **SYSTEM 3E technology**.

Eurocode 6 (standard PN-EN 1996-1-1)

sets dimensions for vertical, horizontal grooves, and recesses excluded from calculations.

Thickness and width of chases and recesses omitted in structural calculations for SYSTEM 3E.

Partition type	Wall thickness without plaster [mm]	Chases and recesses formed after construction of masonry		Maximum depth of vertical and inclined chases omitted in calculations	
		Maximum depth [mm]	Maximum width [mm]	Unlimited length [mm]	Length ≤1250 [mm]
SYSTEM 3E EKO+	352	30	200	20	30

Anchoring – Single and Multipoint

Use flange anchor bolts from **Rawplug (R-FF1...), Hilti (HRD and HUD series...),** or similar for SYSTEM 3E EKO+ and SYSTEM 3E INTERNAL on the substrate.

Index		Installation	Hole diameter [mm]	Effective embedment depth [mm]	Allowable load [kN]	Edge distance [mm]	Spacing of anchors [mm]
Rawplug	R-FF1-N-08	Non-impact drilling	8	70	0,34	100	250
	R-FF-N-10		10	70	0,15	100	250
HILTI	HRD-H		10	50	0,22	100	250
	HUD-L		10	70	0,19	100	250

Applications:

- Door and window frames
- Garage doors
- Industrial gates
- Wall cabinets
- Facades (installation of structural elements made of metal or wood)
- Satellite antennas
- Wall shelves
- Railings
- Cable trays

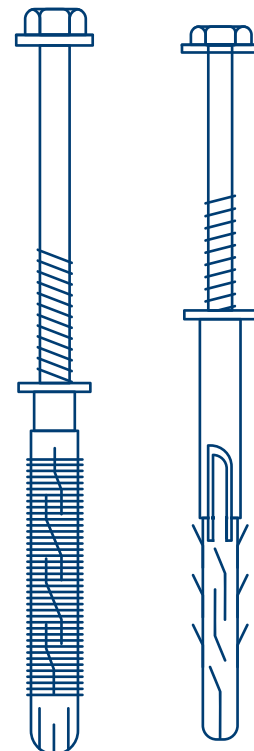

Advanced Anchorings for Demanding Applications

For more demanding applications, use adhesive anchors with threaded rods. Solutions from **Rawplug (R-KEM II...)** and **Hilti (HY170+HAS-U...)** are recommended for SYSTEM 3E EKO+ and SYSTEM 3E INTERNAL.

Index		Installation	Hole diameter [mm]	Effective embedment depth [mm]	Allowable load [kN]	Edge distance [mm]	Spacing of anchors [mm]
Rawplug	R-KEM-II + rod R-STUDS-08110	Non-impact drilling	10	80	0,27	100	250
	R-KEM-II + rod R-STUDS-10130		12	85	0,23	100	250
	R-KEM-II + rod R-STUDS-12160		14	95	0,31	100	250
HILTI	HY 170 + HAS-U M8x80		10	60	0,31	100	250
	HY 170 + HAS-U M8x150		10	120	1,39	100	250

Applications:

- Brackets
- Stair cages
- Gates
- High storage shelves
- Canopies
- Sanitary devices
- Steel structures
- Railings
- Handrails
- Ladders
- Cable trays

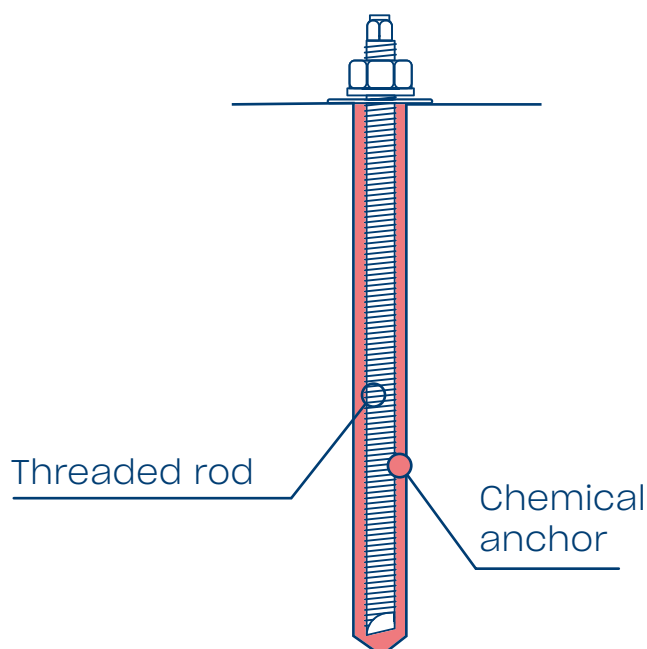

Wall Reinforcement of Openings in SYSTEM 3E Structures

Internally, we recommend using three layers of fiberglass mesh for reinforcing window and door openings (**horizontal, diagonal, and vertical**).

From the **external** side of the building, a layer of adhesive mortar is applied across the entire surface of the walls, embedded with a reinforcing fiberglass mesh.

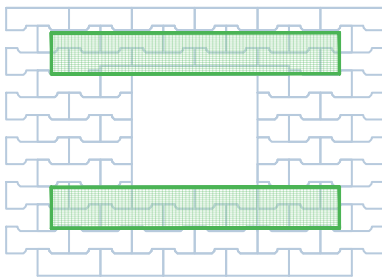

STEP 1

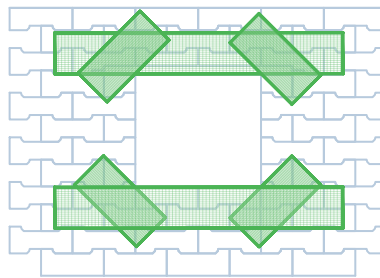

STEP 2

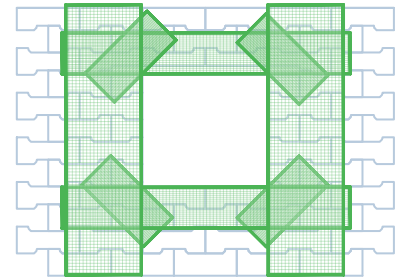

STEP 3

Reinforcement of Concrete Structure Elements

We suggest to our contractors the use of vertical reinforced concrete columns with an **under-plaster mesh throughout the entire height**, especially when SYSTEM 3E is rigidly connected. In cases where the connection is articulated, we incorporate expansion joints between SYSTEM 3E and the reinforced concrete structure.

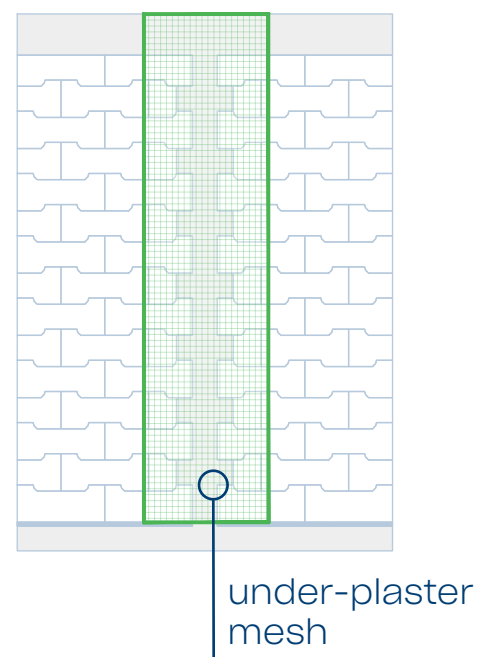

Internal and External Finishing Layers

Finish SYSTEM 3E walls on the interior with a thin plaster layer, considering protection with a primer. Gypsum, lime, and cement-lime plasters can be used.

On the exterior, apply a layer of cement or cement-lime adhesive mortar with embedded fiberglass mesh. Use plaster or facade finishes on this protected

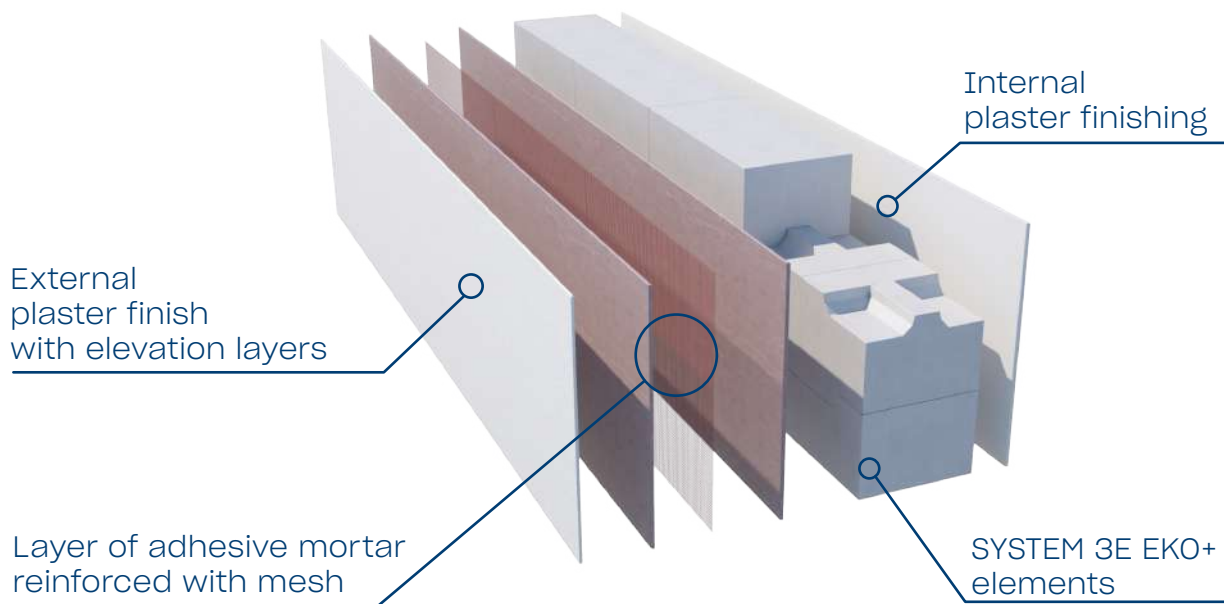

SYSTEM3E®

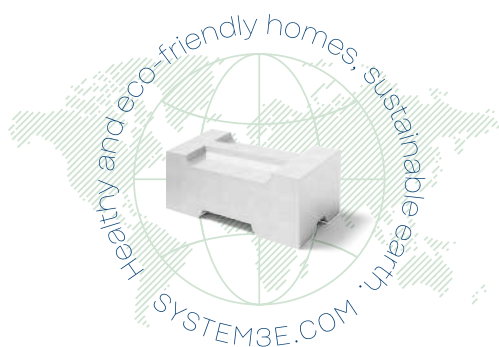

check
the website
system3e.com

SYSTEM 3E S.A.
Rondo ONZ 1
00-124 Warsaw

KRS: 0000796932
NIP: 5252796952
REGON: 383992453

kontakt@system3e.com
+48 533 344 918
www.system3e.com