

SYSTEM3E®

The only sustainable,
self-insulating, jointless
construction system
from perlite
in the world



**Choose an ecological, economical
and energy-efficient solution.**



What we do?

We provide an environmentally friendly product for building our clients' dream homes. We share know-how with architects and contractors, help with project adaptation and provide consultation during construction.

Perlite wall

The warmest, thinnest and most durable single-layer wall available on the EU market.

Who are we?

SYSTEM 3E is an innovative technology for building walls with 3E elements made of natural raw material - perlite. It is the biggest innovation in the construction industry in 100 years!



The modern production process makes the dimensions of the elements very precise and connect perfectly with each other. The structural durability of 3E walls has been confirmed by compression, bending and shear testing. SYSTEM 3E meets all European standards.

The 3E elements are assembled seamlessly, using the "click-click" method. This is possible thanks to the reference at the joints of the elements to the action of a Morse cone. This results in a self-anchoring wall structural system.

Perlite

The heart of SYSTEM 3E technology is perlite, a volcanic rock found all over the world.

Perlite has excellent thermal insulation properties.

The material is fireproof, lightweight, mineral, chemically and biologically inert.

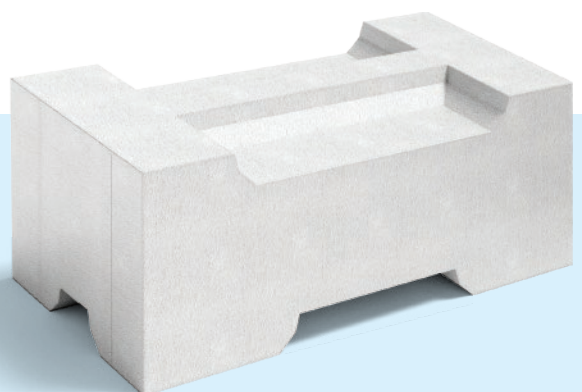

Eco-friendly home is a healthy home



Healthy walls



No mortar or glue is used to build 3E walls, and they do not require any additional insulation. This means no chemicals or artificial materials - making your investment healthy and eco-friendly.

Healthy home microclimate



High water vapor permeability ensures easy air flow and makes the house "breathe". This results in a lack of moisture in the house, and you don't worry about mold or mildew. This solution is ideal for allergy sufferers and asthmatics.

Perfect temperature all year round



Thanks to the excellent properties of perlite, the house is warm during winter so its energy requirement is lower. This not only helps lower heating bills, but also reduces emissions into the atmosphere. On the other hand, during hot weather, you can find comfort in a perlite house - even without air conditioning.

Eco-friendly production process



The production of 3E elements does not require high energy consumption and the entire process was developed according to sustainable principles. During production, CO₂ emissions into the atmosphere were significantly reduced and water consumption was cut by three times. Perlite elements can also be 100% recycled - the recycled raw material will still be ideal for other components of an eco-friendly building.

Designing in SYSTEM 3E

What your architect should know about?



single-family
houses



commercial
buildings



filling of high
frame structures



multi-family houses
and housing estates



public
buildings



load-bearing
walls or filling

Modularity

When designing with SYSTEM 3E technology, we operate with a module of 352 mm. The length of the basic element (S1) is 704 mm.

The effective height of the element is 250 mm.

Basic element S1

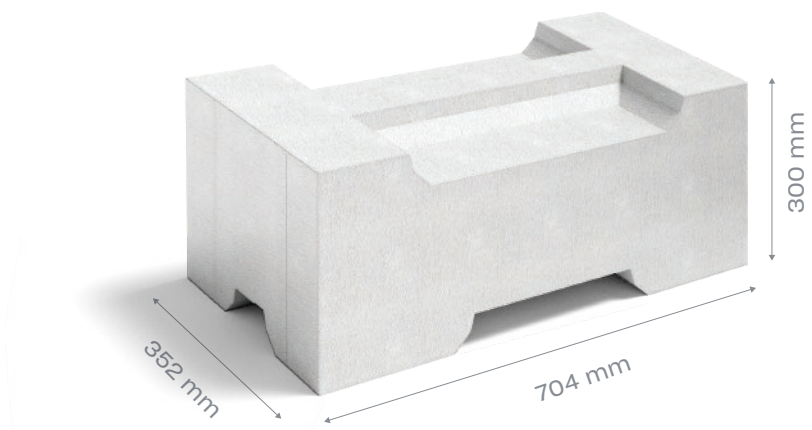

80% of the walls are built with 6 basic elements, the rest are used depending on the complexity of the project.

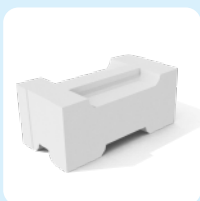

BASIC
ELEMENT S1

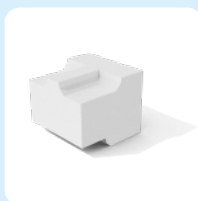

HALF
ELEMENT S1/2

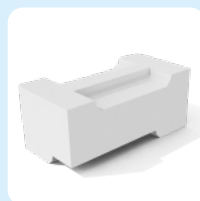

LEFT CORNER
ELEMENT SNL

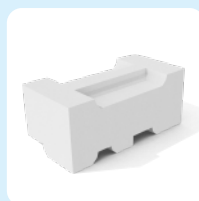

RIGHT CORNER
ELEMENT SNP



ENDING
ELEMENT SZ/EO

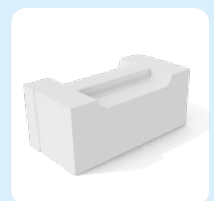

STARTER
ELEMENT SO

Design process

01

The shape of the element is ergonomic enough not to limit the freedom of designing the architecture.

02

It is best to design with the module from the beginning.

03

The module does not make it difficult to perform adaptation.

Wall diagrams

What is unique about our technology is the wall diagrams that come with each project. They are also a manual for the contractor, as they show the exact layout of each element in the wall, and are also used to calculate the specific number of elements for the project.

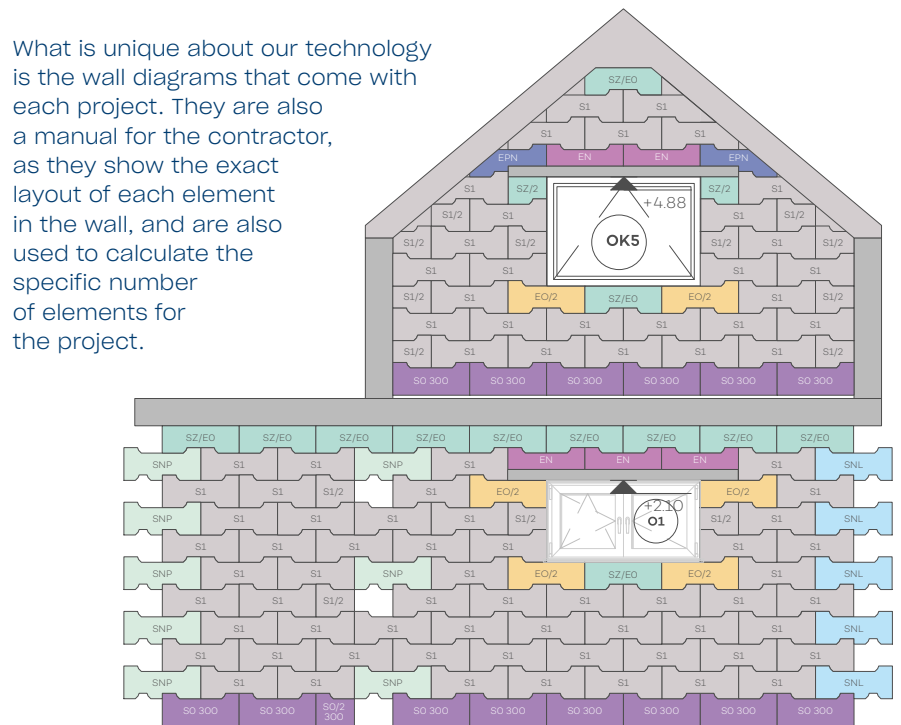

3E technology is compatible with all solutions used in the construction industry:

✓ INDIRECT AND DIRECT FOUNDATIONS

✓ MONOLITHIC AND PREFABRICATED LINTELS

✓ MONOLITHIC, THICK RIBBED, PREFABRICATED CEILING

✓ TRADITIONAL AND PREFABRICATED ROOF TRUSSES



Less reinforced concrete

SYSTEM 3E makes it possible to reduce the number of reinforced concrete elements in a building project.

The idea of prefabrication and healthy perlite walls comes first.



3E corner

We avoid reinforced concrete columns in the corners of the walls due to the fact that the elements connect perfectly at an angle of 90 degrees.

This advantage results from the shape and dimensional accuracy of the 3E elements.

Discover the benefits of 3E

For you:

- ✓ thinnest, warmest and environmentally friendly house walls
- ✓ shorter construction time vs. traditional methods
- ✓ the only construction and insulation material made of perlite - safe for health and the environment
- ✓ the best choice for you and your family

For your architect:

- ✓ free training and technical advice
- ✓ starter files for designing in CAD environment
- ✓ database of recommended design details
- ✓ 3E architect support at the design stage

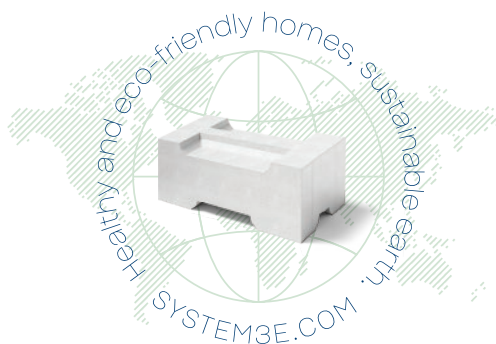

Questions? Contact us:

e-mail: contact@system3e.com
tel.: +48 533 344 918

SYSTEM 3E, Rondo ONZ 1
Warsaw, Poland



SYSTEM 3E



SYSTEM 3E



SYSTEM3E_technology



SYSTEM 3E

